

Datasheet

Length overall (LOA)	11.64 m
Hull Length	11.06 m
Beam (BOA)	3.63 m
Total height with engine **	3.44 m
Height from waterline **	2.96 m
Height from waterline	1.50 m
Draught w/o engine	0.48 m
Weight w/o engine	6100 kg
Max load	2000 kg
Persons	10
Classification	B
Maximum engine power	2x350 HP
Fuel tank capacity	700 L
Fresh water tank capacity	200 L

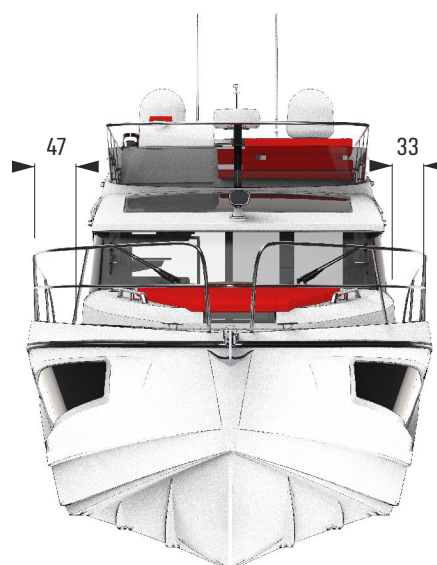

* All images are perspective views. Do not use for reference.
 ** Without accessories.

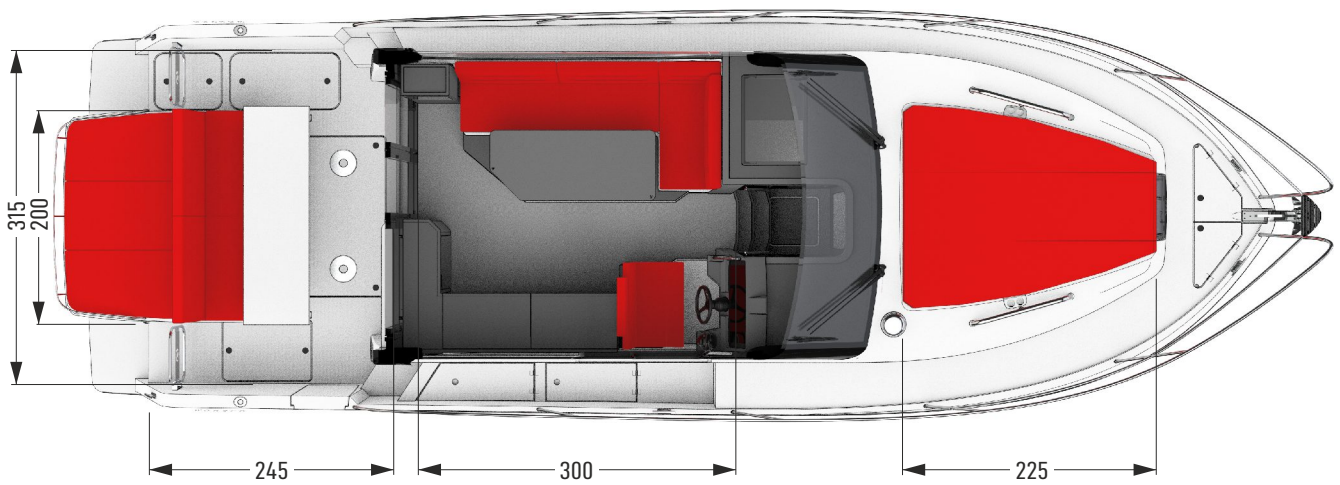
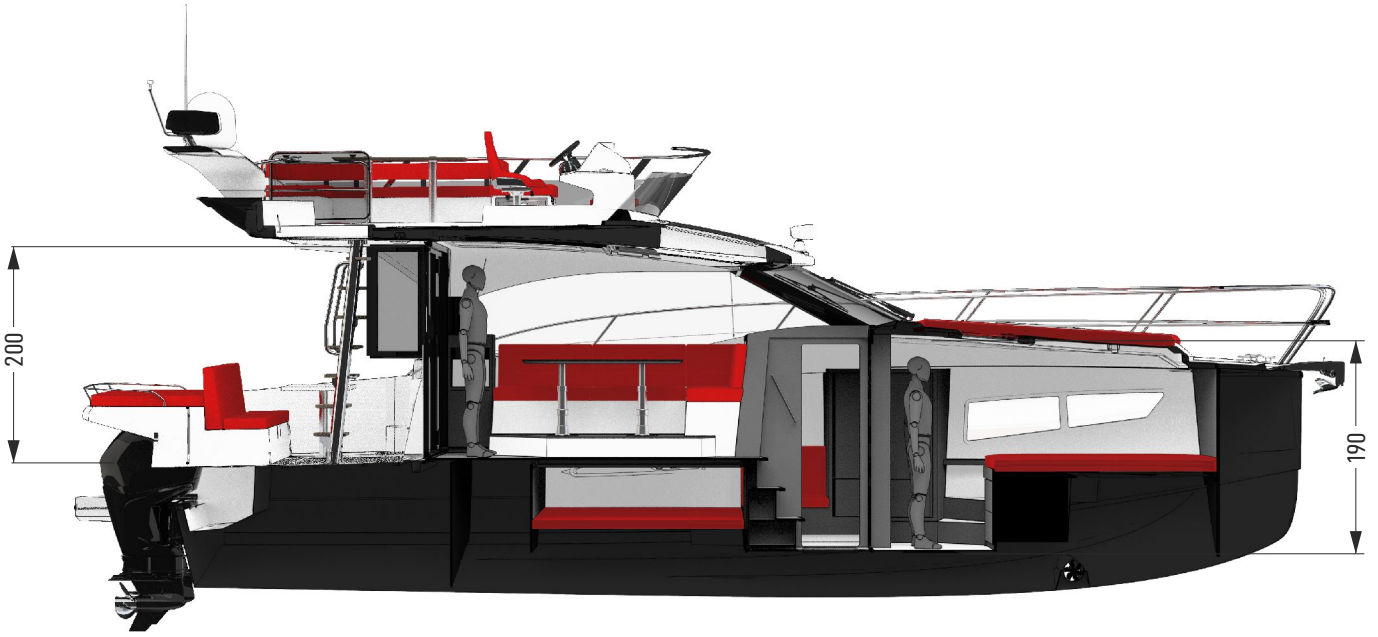

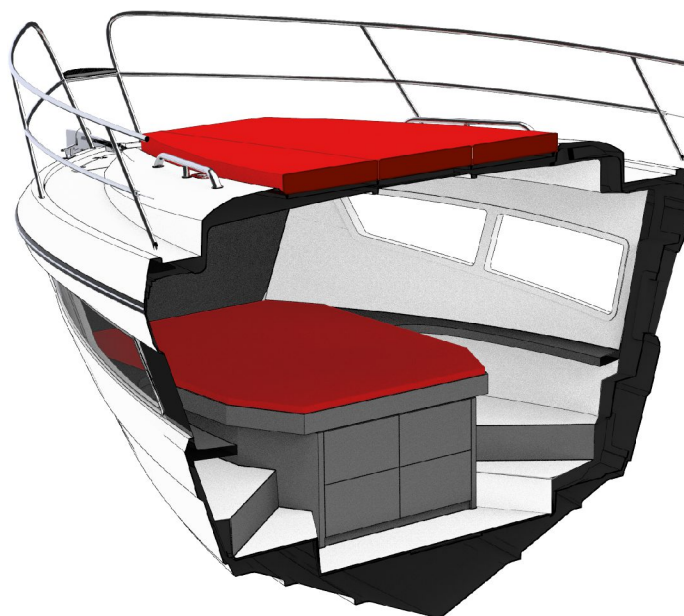
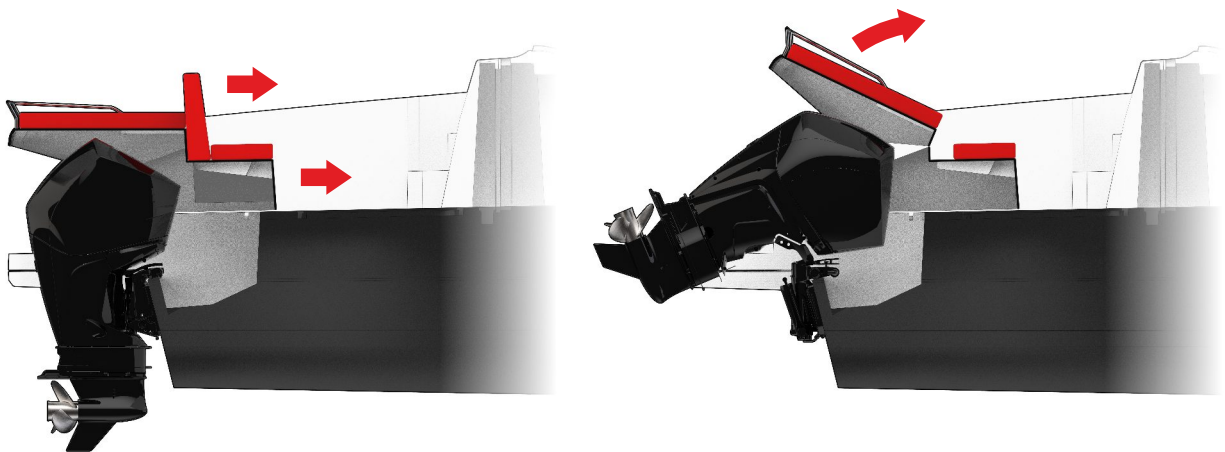
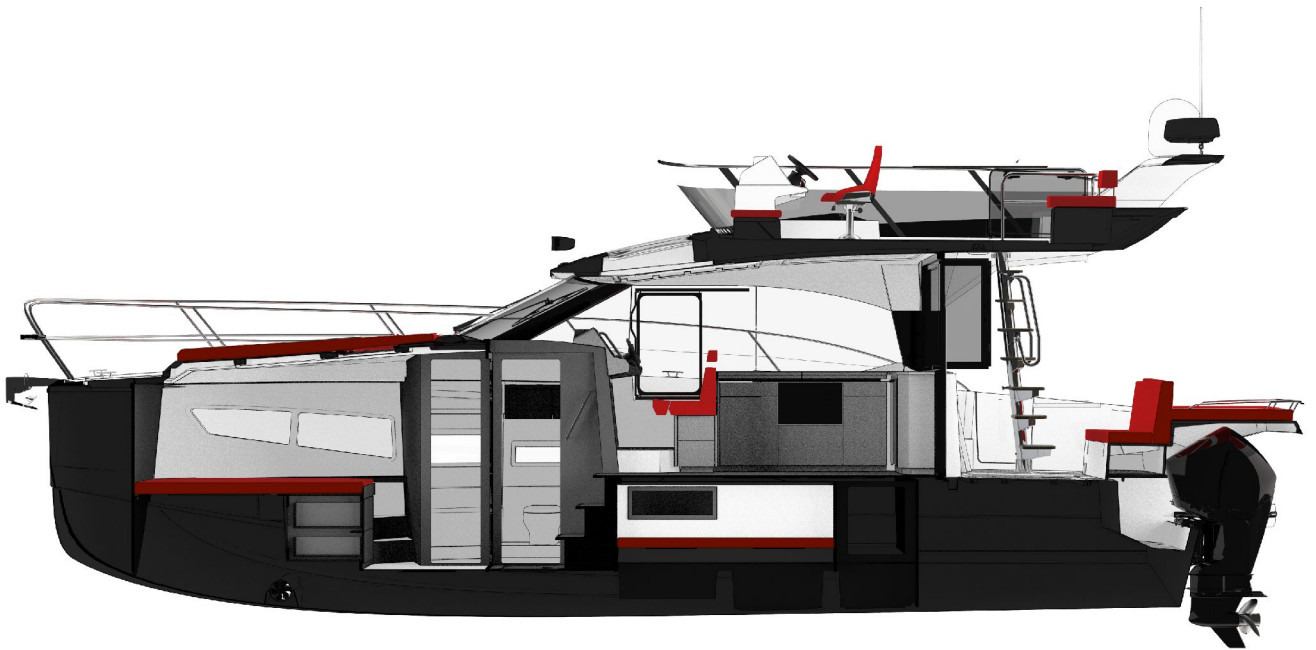

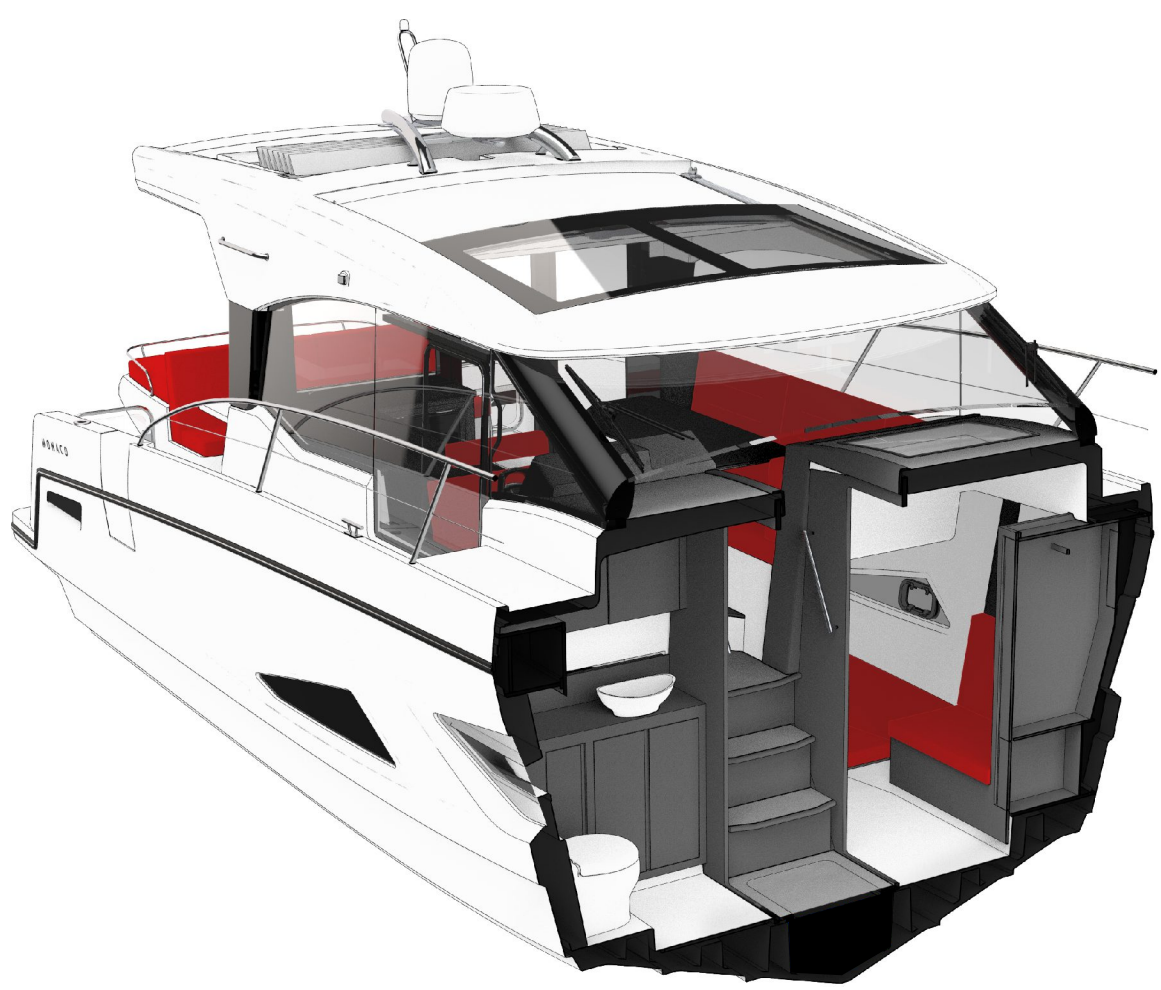
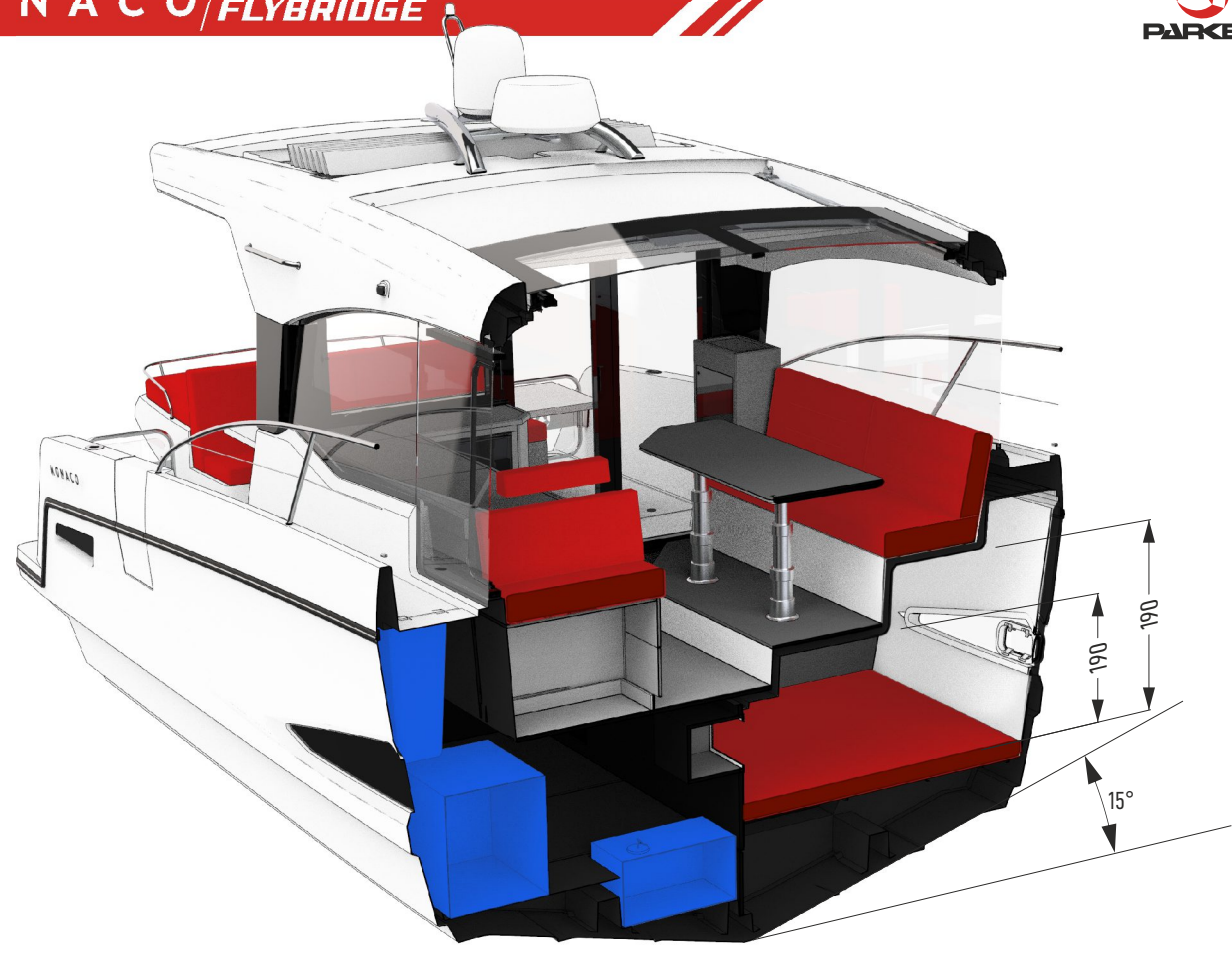

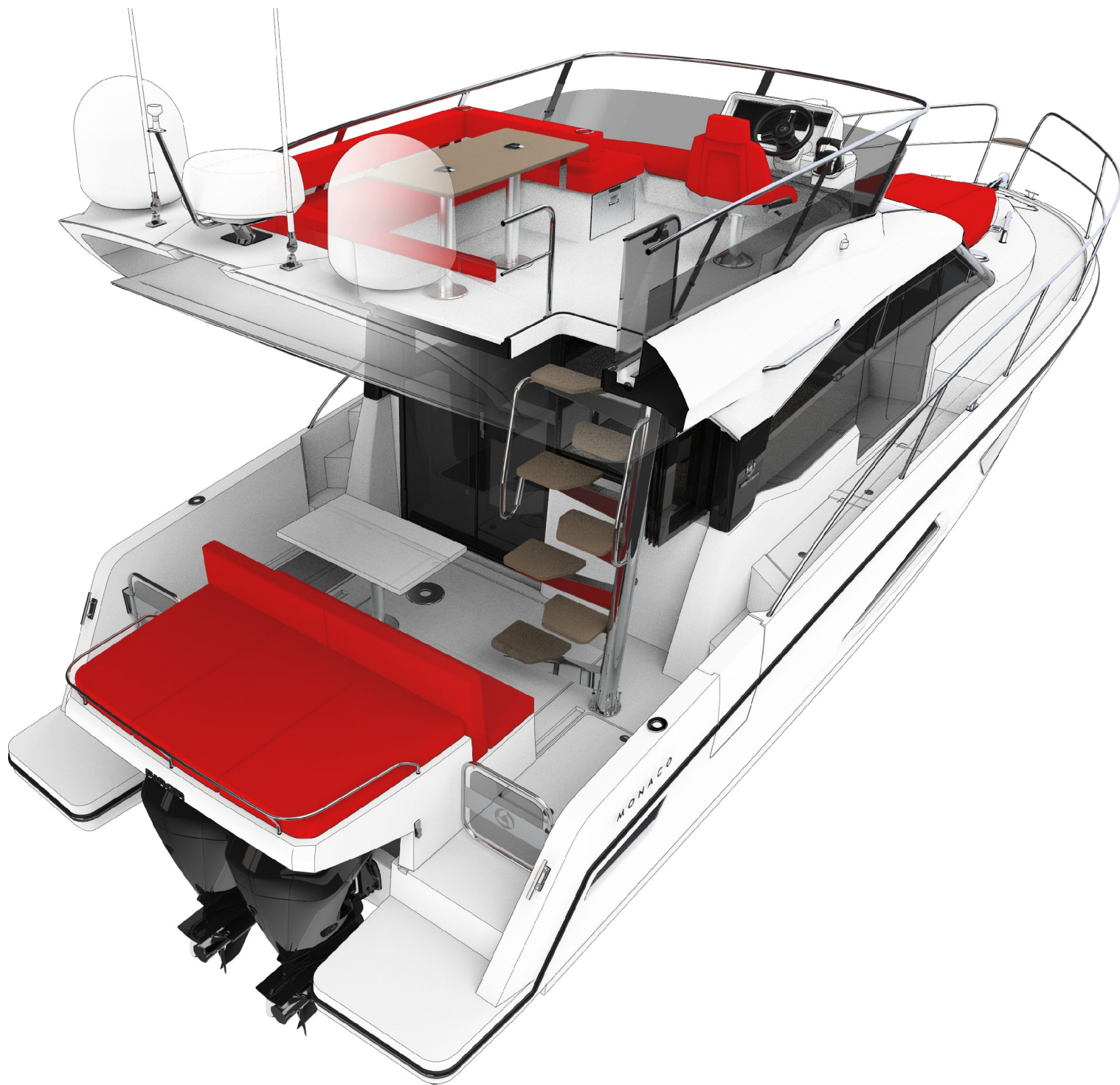

* All images are perspective views. Do not use for reference.